

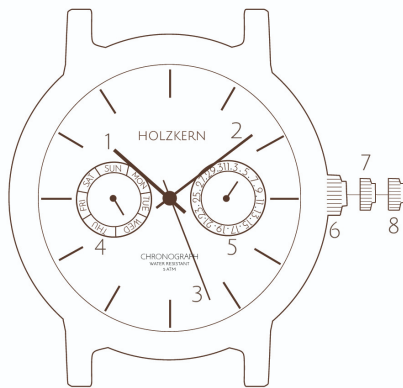





DE | EN | ES | IT | FR | NL | DA



- 1 Hour | Stunde
- 2 Minute | Minute
- 3 Second | Sekunde
- 4 Day | Tag
- 5 Date | Datum
- 6 Normal position | Normalposition
- 7 1st click | 1. Position
- 8 2nd click | 2. Position

<p>Battery Batterie SR920SW</p> <p>Movement Uhrwerk Quartz movement Quarzuhrwerk Seiko VH64</p> <p>Water resistance Wassersäule 10 ATM</p> <p>Glass Glas Sapphire crystal Saphirglas</p> <p>Case thickness Gehäusehöhe 12,3 mm</p> <p>Weight Gewicht 192 g</p> <p>Caseback Rückseite Gehäuse Metal, Glass Metall, Glas</p>	<p>Circumference Umfang Adjustable length Größenverstellbar</p> <p>Band width Armbandbreite 22 mm</p> <p>Band Armband Metal, wood Metall, Holz Screws Schrauben</p> <p>Closure Verschluss Butterfly clasp Schmetterlingsverschluss</p> <p>Case connection Gehäuseverbindung Spring pin with lever Federstift mit Hebel</p> <p>luminescent lumineszierend hands and markers Zeiger und Markierung</p>
---	--

<p>Instructions Band Anleitung Armband Instrucciones para la correa Istruzioni per il cinturino Instructions pour le bracelet Instructies Horlogeband Instruktioner rem</p>	
 <p>EN: www.holz kern.com/en/faq/#size DE: www.holz kern.com/de/faq/#size ES: www.holz kern.com/es/faq/#size IT: www.holz kern.com/it/faq/#size</p>	<p>FR: www.holz kern.com/fr/faq/#size NL: www.holz kern.com/nl/faq/#size DA: www.holz kern.com/da/faq/#size</p>

 <p>Accuracy/Month Genauigkeit/Monat</p>	<p>± 20 sec. ± 20 Sek.</p>	 <p>Battery life Batterie Lebensdauer</p>	<p>2 Years 2 Jahre</p>
---	--------------------------------	--	----------------------------

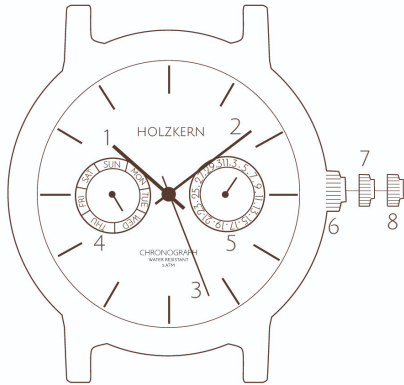

- 1** Hour | Stunde
- 2** Minute | Minute
- 3** Second | Sekunde
- 4** Day | Tag
- 5** Date | Datum
- 6** Normal position | Normalposition
- 7** 1st click | 1. Position
- 8** 2nd click | 2. Position

Setting the time

To set the time, pull the crown out to the 2nd Position. Then turn the crown to set hour and minute hands. After setting the time, push the crown back to normal position and the watch begins to run.

Setting the day and date

To set the day and the date, pull the crown out in position one. To set the date, turn the crown counterclockwise, to set the day turn it clockwise. After the day and date has been set, push the crown back to the normal position.

**Don't set the date between 21:00 and 01:00 (the date may not change the next day).*

Uhrzeit einstellen

Um die Uhrzeit einzustellen, ziehe die Krone sanft raus bis in Position 2. Drehe dann die Krone, um den Stunden- und Minutenzeiger einzustellen. Danach drücke die Krone wieder in Normalposition.

Wochentag und Datum einstellen

Ziehe die Krone in Position 1 um den Wochentag und das Datum einzustellen. Zum Einstellen des Datums drehe die Krone gegen den Uhrzeigersinn, um den Wochentag einzustellen, drehe die im Uhrzeigersinn. Drücke danach die Krone wieder in Normalposition zurück.

**Stelle das Datum nicht zwischen 21:00 und 01:00 Uhr ein (das Datum stellt sich sonst am nächsten Tag nicht richtig um).*



Accuracy/Month
Genauigkeit/Monat

± 20 sec.
± 20 Sek.



Battery life
Batterie Lebensdauer

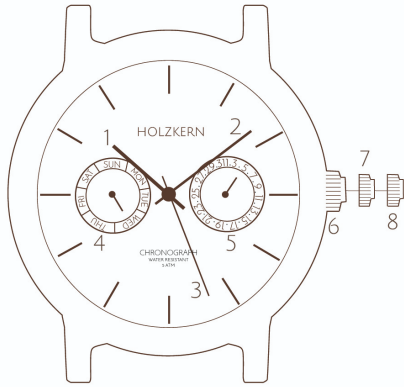

2 Years
2 Jahre



- 1 Hora | Ore
- 2 Minuto | Minuti
- 3 Segundo | Secondi
- 4 Día de la semana | Giorno feriale
- 5 Fecha | Data
- 6 Posición normal | Azzeramento
- 7 Posición 1 | Posizione 1
- 8 Posición 2 | Posizione 2

<p>Batería Batteria SR920SW</p> <p>Movimiento Movimento Movimiento de Cuarzo Movimento al quarzo Seiko VH64</p> <p>Resistencia al agua Resistenza all'acqua 10 ATM</p> <p>Cristal Vetro Cristal de zafiro Vetro zaffiro</p> <p>Grosor de la caja Spessore della cassa 12,3 mm</p> <p>Peso Peso 192 g</p> <p>Parte trasera de la caja Fondello Metal, Cristal Metallo, Verto</p>	<p>Circunferencia Circonferenza Longitud ajustable Lunghezza regolabile</p> <p>Longitud de la correa Larghezza cinturino 22 mm</p> <p>Correa Cinturino Meal, Madera Metallo, Legno Pasador tornillo Viti</p> <p>Cierre Chiusura Cierre de mariposa Chiusura a farfalla</p> <p>Conexiones de la caja Alette Pasador de resorte con palanca Perno con leva</p> <p>luminiscentes luminescenti Agujas y marcas Lancette e marcatori</p>
--	---

<p>Instructions Band Anleitung Armband Istrucciones para la correa Istruzioni per il cinturino Instructions pour le bracelet Instructies Horlogeband Instruktioner rem</p>	
	<p>EN: www.holz kern.com/en/faq/#size</p> <p>DE: www.holz kern.com/de/faq/#size</p> <p>ES: www.holz kern.com/es/faq/#size</p> <p>IT: www.holz kern.com/it/faq/#size</p>
	<p>FR: www.holz kern.com/fr/faq/#size</p> <p>NL: www.holz kern.com/nl/faq/#size</p> <p>DA: www.holz kern.com/da/faq/#size</p>

	<p>Precisión/Mes Perdita di secondi mensili</p>	<p>± 20 sec. ± 20 Sek</p>		<p>Duración de la batería Autonomia della batteria</p>	<p>2 Años 2 Anni</p>
---	---	-------------------------------	---	--	--------------------------

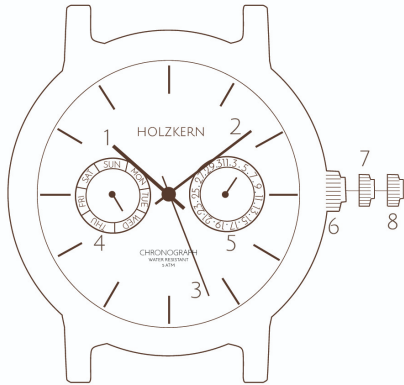

- 1** Hora | Ore
- 2** Minuto | Minuti
- 3** Segundo | Secondi
- 4** Día de la semana | Giorno feriale
- 5** Fecha | Data
- 6** Posición normal | Azzeramento
- 7** Posición 1 | Posizione 1
- 8** Posición 2 | Posizione 2

Establecer la hora

Para ajustar la hora, tira de la corona hasta la posición 2. Después gira la corona para ajustar las manecillas de las horas y los minutos. Después de ajustar la hora, vuelve a colocar la corona en la posición normal y el reloj comenzará a funcionar.

Configurar el día y la fecha

Para configurar el día y la fecha, tire de la corona hasta la posición 1. Para fijar la fecha, gira la corona en sentido contrario a las agujas del reloj. Para fijar el día, gírela en sentido de las agujas del reloj. Después de configurar el día y la fecha, vuelve a colocar la corona en la posición normal.

* No configures la fecha entre las 21:00 y la 01:00 (es posible que la fecha no cambie al día siguiente).

Impostazione dell'ora

Per impostare l'ora, estrarre la corona fino alla posizione 2. Poi girare la corona per impostare le lancette delle ore e dei minuti. Dopo aver impostato l'ora, spingere la corona di nuovo nella posizione iniziale e l'orologio inizierà a funzionare.

Impostazione del giorno e della data

Per impostare il giorno e la data, tirare la corona nella posizione 1. Per impostare la data, girare la corona in senso antiorario, per impostare il giorno girarla in senso orario. Dopo aver impostato il giorno e la data, spingere la corona nella posizione iniziale.

*Non impostare la data tra le 21:00 e le 01:00 (la data potrebbe non cambiare il giorno successivo).



Precisión/Mes
Perdita di secondi mensili

± 20 sec.
± 20 Sek



Duración de la batería 2 Años
Autonomia della batteria 2 Anni

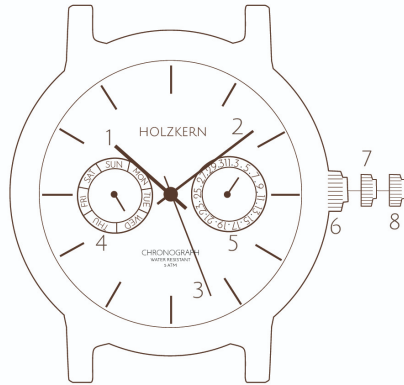

- 1 *Heure* | Uur
- 2 *Minute* | Minuut
- 3 *Seconde* | Seconde
- 4 *Semaine* | Doordeweeks
- 5 *Date* | Datum
- 6 *Position normale* | Standaard positie
- 7 *Position 1* | Positie 1
- 8 *Position 2* | Positie 2

Batterie | Batterij

SR920SW

Mouvement | UurwerkMouvement à quartz | Quartz-uurwerk
Seiko VH64**Étanchéité | Waterdicht**

10 ATM

Verre | Glas

Verre saphir | Saffierglas

Épaisseur du boîtier | Kastdikte

12,3 mm

Poids | Gewicht

192 g

Verso du boîtier | Achterkant van de kast

Métal, Verre | Metaal, Glas

Circonférence | Omvang

Longueur ajustable | Verstelbare lengte

Largeur du bracelet | Bandbreedte

22 mm

Bracelet | HorlogebandMétal, Bois | Metaal, Hout
Vis | Schroeven**Fermeture | Sluiting**

Fermoir papillon | Vlindersluiting

Attaches | Kastbevestiging

Fermoir à levier | Veerpin met hefboom

Luminescents | Lichtgevende

Aiguilles et marqueurs | Wijzer en markeringen

Instructions Band | Anleitung Armband | Instrucciones para la correa | Istruzioni per il cinturino | Instructions pour le bracelet | Instructies Horlogeband | Instruktioner rem

EN: www.holz kern.com/en/faq/#size
 DE: www.holz kern.com/de/faq/#size
 ES: www.holz kern.com/es/faq/#size
 IT: www.holz kern.com/it/faq/#size

FR: www.holz kern.com/fr/faq/#size
 NL: www.holz kern.com/nl/faq/#size
 DA: www.holz kern.com/da/faq/#size



Précision / Mois ± 20 sec.
Nauwkeurigheid/Maand ± 20 Sek.



Durée de vie de la batterie 2 Années
Levensduur batterij 2 Jaren



DE | EN | ES | IT | FR | NL | DA

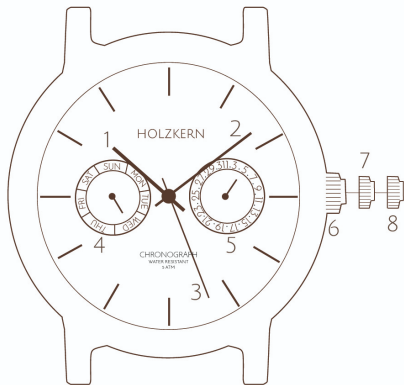

- 1** Heure | Uur
- 2** Minute | Minuut
- 3** Seconde | Seconde
- 4** Semaine | Doordeweeks
- 5** Date | Datum
- 6** Position normale | Standaard positie
- 7** Position 1 | Positie 1
- 8** Position 2 | Positie 2

Réglage de l'heure

Pour régler l'heure, tirer la couronne en position 2. Tourner ensuite la couronne pour régler les aiguilles des heures et des minutes. Après avoir réglé l'heure, repousser la couronne en position normale afin que la montre se remette à fonctionner.

Réglage du jour et de la date

Pour régler le jour et la date, tirer la couronne en position 1. Pour régler la date, tourner la couronne dans le sens inverse des aiguilles d'une montre. Pour régler le jour, la tourner dans le sens des aiguilles d'une montre. Une fois le jour et la date réglés, repousser la couronne en position initiale.

* Ne pas régler la date entre 21h00 et 01h00 (la date peut ne pas changer le jour suivant).

De tijd instellen

Om de tijd in te stellen, trek de kroon uit tot de positie 2. Draai vervolgens aan de kroon om de uren- en minutenwijzers in te stellen. Na het instellen van de tijd, druk de kroon terug in de standaard positie en het horloge begint te lopen.

Dag en datum instellen

Om de dag en de datum in te stellen, trek de kroon uit in positie 1. Om de datum in te stellen draai je de kroon tegen de klok in, om de dag in te stellen draai je de kroon met de klok mee. Nadat de dag en de datum zijn ingesteld, druk je de kroon terug in de standaard positie.

*Stel de datum niet in tussen 21:00 en 01:00 (de datum mag de volgende dag niet veranderen).



Précision / Mois ± 20 sec.
Nauwkeurigheid/Maand ± 20 Sek.



Durée de vie de la batterie 2 Années
Levensduur batterij 2 Jaren

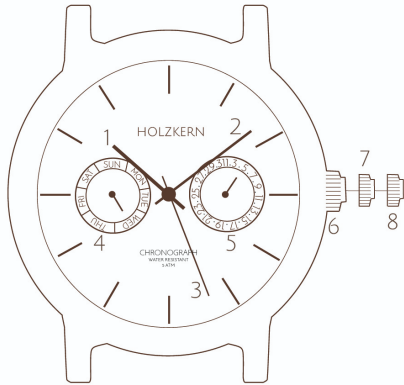

- 1 Time
- 2 Minut
- 3 Sekund
- 4 Hverdag
- 5 Dato
- 6 Normal position
- 7 1-position
- 8 2-position

<p>Batteri SR920SW</p> <p>Urværk Kvartsurværk Seiko VH64</p> <p>Vandtæt 10 ATM</p> <p>Glas Safirglas</p> <p>Urkasse højde 12,3 mm</p> <p>Vægt 192 g</p> <p>Bagsiden af urkassen Metal, Glas</p>	<p>Omkreds Justerbar længde</p> <p>Armbåndsbredde 22 mm</p> <p>Rem Metal, Træ Skruer</p> <p>Lås Sommerfuglelås</p> <p>Forbindelse til urkasse Fjederben med håndtag</p> <p>Selvlysende Visere og markører</p>
--	---

Instructions Band | Anleitung Armband | Instrucciones para la correa | Istruzioni per il cinturino | Instructions pour le bracelet | Instructies Horlogeband | Instruktioener rem



EN: www.holzkern.com/en/faq/#size
 DE: www.holzkern.com/de/faq/#size
 ES: www.holzkern.com/es/faq/#size
 IT: www.holzkern.com/it/faq/#size

FR: www.holzkern.com/fr/faq/#size
 NL: www.holzkern.com/nl/faq/#size
 DA: www.holzkern.com/da/faq/#size



Nøjagtighed/Måned

± 20 sec.



Batteri liv

2 År

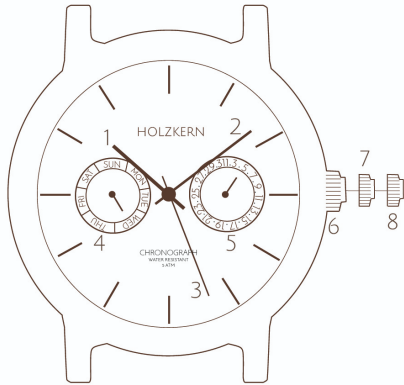

- 1 Time
- 2 Minut
- 3 Sekund
- 4 Hverdag
- 5 Dato
- 6 Normal position
- 7 1-position
- 8 2-position

Indstilling af tid

For at indstille klokkeslættet skal du trække kronen ud til 2. position. Drej derefter kronen for at indstille timer og minutter. Når tiden er indstillet, skal du skubbe kronen tilbage til normal position, og uret begynder at køre.

Indstilling af dag og dato

For at indstille dagen og datoen skal du trække kronen ud i position 1. For at indstille datoen skal du dreje kronen mod uret for at indstille dagen dreje den med uret. Når dagen og datoen er indstillet, skal du skubbe kronen tilbage til den normale position.

** Indstil ikke datoen mellem 21:00 og 01:00 (ellers ændres datoen muligvis ikke den næste dag).*



Nøjagtighed/Måned

± 20 sec.



Batteri liv

2 År